

ECOFLOW

MAX

EcoFlow RIVER Max | User Manual

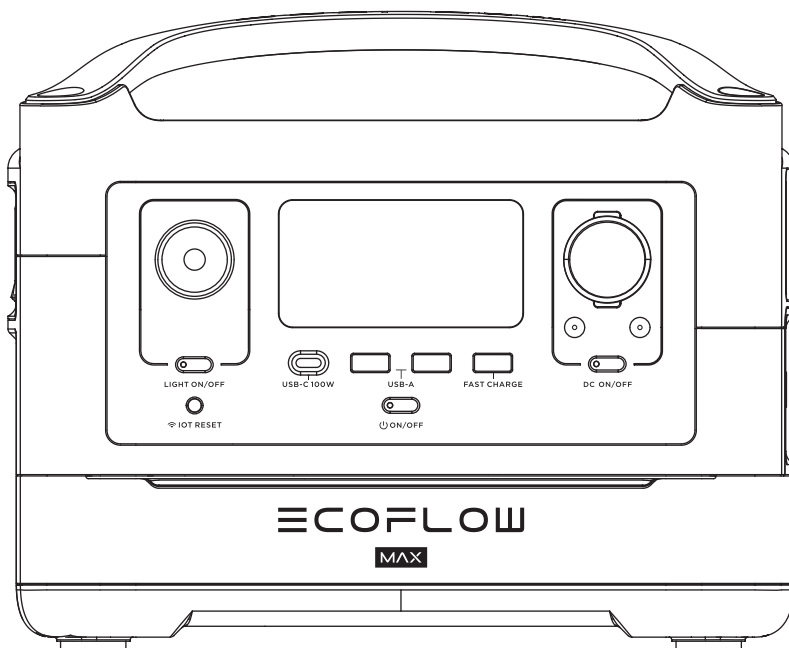

DISCLAIMER

Read all safety tips, warning messages, terms of use, and disclaimers carefully. Refer to the terms of use and disclaimer at <https://ecoflow.com/pages/terms-of-use> and stickers on the product before use. Users take full responsibility for all usage and operations. Familiarize yourself with the related regulations in your area. You are solely responsible for being aware of all relevant regulations and using EcoFlow products in a way that is compliant.

CONTENTS

1. Specifications	1
2. Safety Instructions	
2.1 Usage	2
2.2 Disposal Guide	2
3. Getting Started	
3.1 Product Details	3
3.2 LCD Screen	4
3.3 General Product Usage	4
3.4 AC Charging	6
3.5 Solar Charging	6
3.6 Car Charging	7
3.7 APP	7
3.8 X-Boost	8
3.9 Emergency Power Supply (EPS)	8
4. FAQs	9
5. Troubleshooting	10
6. What's In the Box	11
7. Storage & Maintenance	11

1. Specifications

General Info

Net Weight	Approximately 17 lbs
Dimensions	11.4in x 7.3in x 9.3in
Capacity	576Wh 28.8V
Certification	UL Standard, CE, FCC, RoHS, RCM
Wi-Fi	Supported

Output Ports

AC (x3)	Pure Sine Wave, 600W (Surge 1200W), 120V~ (60Hz)
Max Device(s) Power Supported by X-Boost	1800W
USB-A (x2)	5V $\overline{\text{---}}$ 2.4A 12W max, per port
USB-A Fast Charge (x1)	5V $\overline{\text{---}}$ 2.4A 9V $\overline{\text{---}}$ 2A 12V $\overline{\text{---}}$ 1.5A 18W Max, per port
USB-C (x1)	5/9/12/15/20V $\overline{\text{---}}$ 5A 100W max, per port
Car Charger(x1)	13.6V $\overline{\text{---}}$ 10A, 136W max
DC5521 Output (x2)	13.6V $\overline{\text{---}}$ 3A, per port

* Car charger shares power with the DC5521 output port, offering a maximum output of 136W.

Input Ports

AC Charge	X-Stream Fast Charge 500W max
AC Input Voltage	100-120V~ 60Hz
Solar Charger	10-25V $\overline{\text{---}}$ 12A, 200W max
Car Charger	Supports 12V Battery, 8A

Battery Info

Cell Chemistry	Lithium-ion
Shelf Life	1 year (after a full charge)
Cycle Life	800 cycles to 80%+ capacity
Protection	Over Voltage Protection, Overload Protection, Over Temperature Protection, Short Circuit Protection, Low Temperature Protection, Low Voltage Protection, Overcurrent Protection

Environmental Operating Temperature

Optimal Operating Temperature	68°F to 86°F
Discharge Temperature	-4°F to 140°F
Charge Temperature	32°F to 113°F
Storage Temperature	-4°F to 113°F (optimal: 68°F to 86°F)

* Whether the product can be charged or discharged depends on the actual temperature of the battery pack.

2. Safety Instructions

2.1 Usage

1. Do not use the product near a heat source, such as a fire source or a heating furnace.
2. Avoid contact with any liquid. Do not immerse the product in water or get it wet. Do not use the product in rain or humid environments.
3. Do not use the product in an environment with strong static electricity/magnetic fields.
4. Do not disassemble the product in any way or pierce the product with sharp objects.
5. Avoid using wires or other metal objects that may result in a short circuit.
6. Do not use unofficial components or accessories. If you need to replace any components or accessories, please visit official EcoFlow channels to check relevant information.
7. When using the product, please strictly follow the operating environment temperature specified in this user manual. If the temperature is too high, it may result in a fire or explosion; if the temperature is too low, the product performance may be severely reduced, or the product may cease to work.
8. Do not stack any heavy objects on the product.
9. Do not lock the fan forcibly during use or place the product in an unventilated or dusty area.
10. Please avoid impact, falls, or severe vibrations when using the product. In case of a severe external impact, turn off the power supply immediately and stop using the product. Ensure the product is well fastened during transportation to avoid vibrations and impacts.
11. If you accidentally drop the product into water during use, please place it in a safe open area, and stay away from it until it is completely dry. The dried product should not be used again, and should be properly disposed of according to Section 2.2 below. If the product catches fire, we recommend that you use the fire extinguishers in the following order: water or water mist, sand, fire blanket, dry powder, and finally a carbon dioxide fire extinguisher.
12. Use a dry cloth to clean off dirt on the product ports.
13. Rest the product on a flat surface to avoid damages caused by the product falling over. If the product is overturned and severely damaged, turn it off immediately, place the battery in an open area, keep it away from combustible matter and people, and dispose of it in accordance with local laws and regulations.
14. Ensure that the product is kept out of reach of children and pets.

2.2 Disposal Guide

1. If conditions permit, make sure that the battery is fully discharged before disposing it in a designated battery recycling bin. The product contains batteries with potentially dangerous chemicals, so it is strictly prohibited to dispose of it in ordinary trash cans. For more details, please follow the local laws and regulations on battery recycling and disposal.
2. If the battery cannot be fully discharged due to a product failure, please do not dispose of the battery directly in the battery recycling box. In such case, you should contact a professional battery recycling company for further processing.
3. Please dispose of over-discharged batteries that cannot be recharged.

3. Getting Started

3.1 Product Details

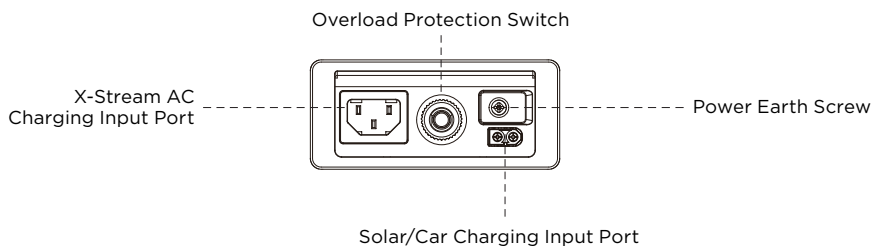
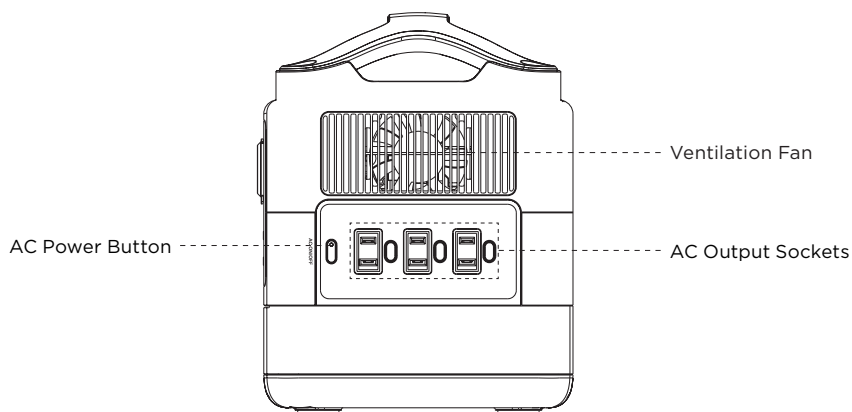
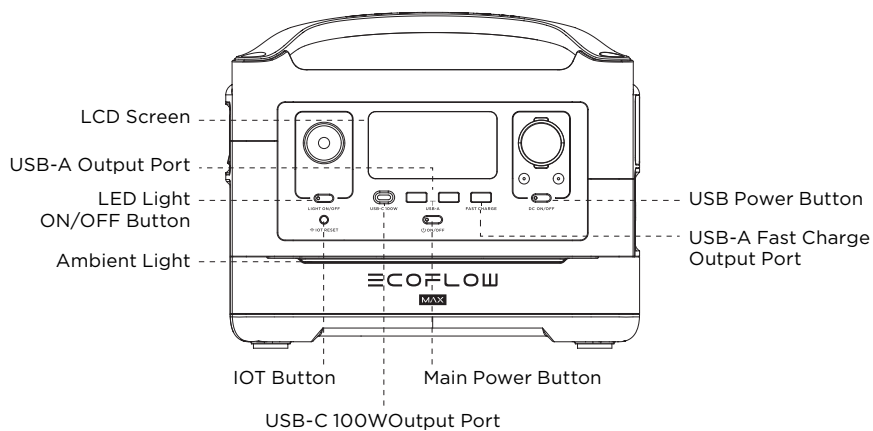

3.2 LCD Screen

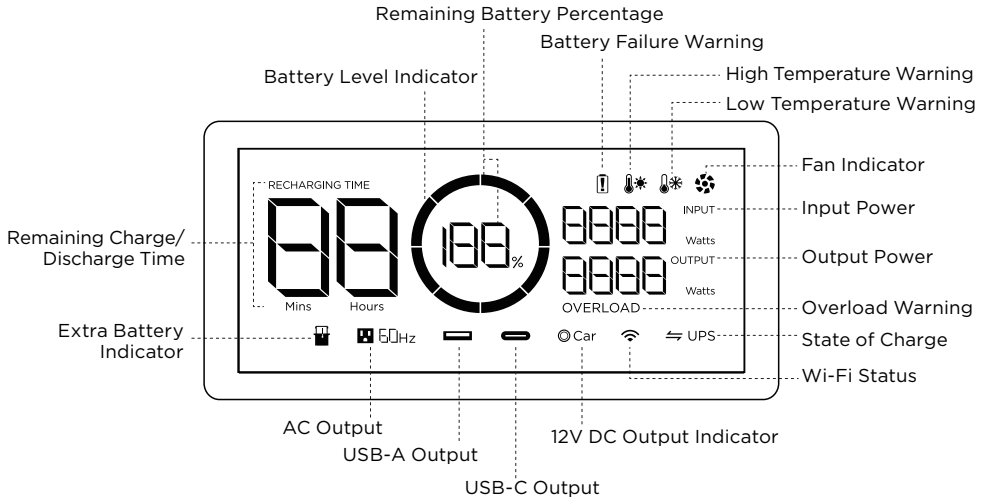

Battery Level Indicator: The indicator will repeatedly fill while charging. If product is at 0% charge, the indicator will flash to warn you.

Wi-Fi Status: After pressing the IOT button for 3 seconds, the Wi-Fi status will flash on the LCD screen which indicates that the product is ready for pairing. There're two ways to connect the product with the App, either directly connect to the product's hotspot or using the Internet. If the App is successfully connected to the product's hotspot, the icon will keep flashing; if it is successfully connected to the Internet, the icon will stay on.

* See Section 5 for more troubleshooting steps.

3.3 General Product Usage

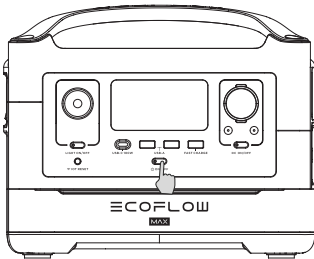

Short Press to Turn On

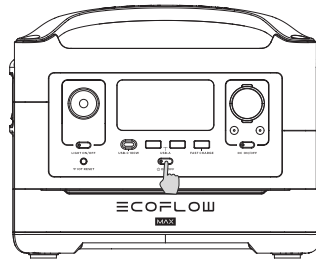

Long Press to Turn Off

Product On, Product Off, LCD Screen On

Short press the Main Power Button to turn on the product; the LCD Screen will light up and the battery level indicator icon will display.

The product enters sleep mode after 5 minutes of idle operation; the LCD Screen will automatically turn off. When the product senses any load change or operations, the LCD Screen will automatically light up. To turn the LCD Screen on or off, please short press the Main Power Button.

To power off the product, press and hold the Main Power Button.

The default product standby time is 2 hours. With other Power Buttons turned off and no other load access for 2 hours, the product will automatically shut down. The standby time can be set on the App.

With the Main Power Button turned on, short press the 12V DC Power Button to use the 12V DC Output port. Short press the 12V DC Power Button again to turn it off.
With the 12V DC Power Button on, the product will not automatically shut down.

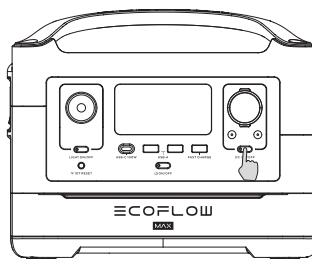

Short Press
12V DC Power Button

AC Output Port

With the Main Power Button turned on, short press the AC Power Button to use the AC Output ports. Short press the AC Power Button again to turn it off.

The default standby time of the AC Output port is 12 hours. Without any load access for 12 hours, the AC Power Button will automatically turn off.

Please turn off AC power button when not in use to save power consumption.

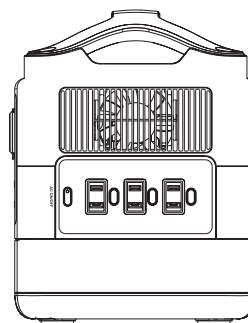

Short Press
AC Power Button

3.4 AC Charging

EcoFlow's X-Stream fast charge technology is specifically for AC charging, offering 500W of max input power. In case of unusual situations where the AC input current remains higher than 10A, the X-Stream charging input port will initiate a self-protection function, and the Overload Protection Switch on the product will automatically pop up. After confirming that there is no product failure, you can press the Overload Protection Switch to resume charging.

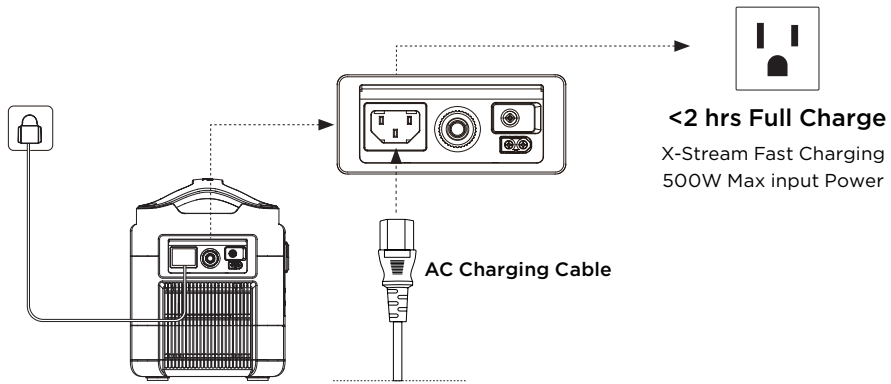

3.5 Solar Charging

Users can connect solar panels in series as shown in the figure to recharge the product. The product supports 10-25V DC input, 12A max current, and 200W max charging power.

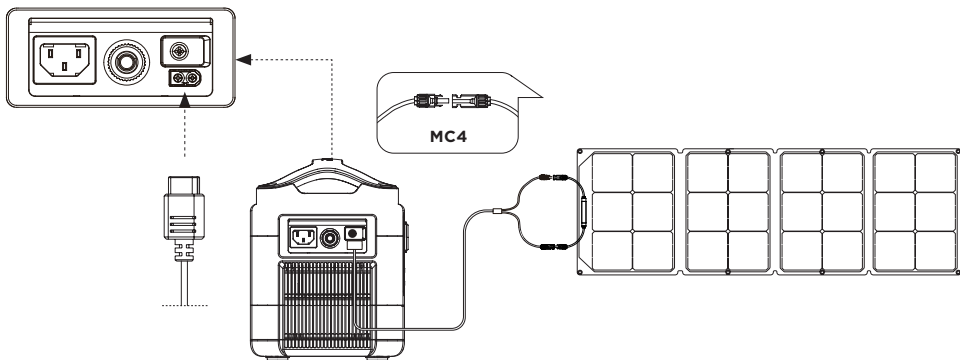

When using an EcoFlow solar panel to charge the product, please follow the instructions that come with the solar panel.

Before connecting the solar panel, please ensure that the solar panel's output voltage is within 25V to avoid product damages.

3.6 Car Charging

Users can recharge the product through the Car Charging Input Port. It supports 12V car chargers and an 8A Max charging current.

Please charge using the car charger after you've started the car to avoid failure to start due to insufficient car battery. In addition, please make sure that Car Charging Input Port and the Car Charging Cable are in good condition. EcoFlow takes no responsibilities for any losses or damages caused by failures to follow instructions.

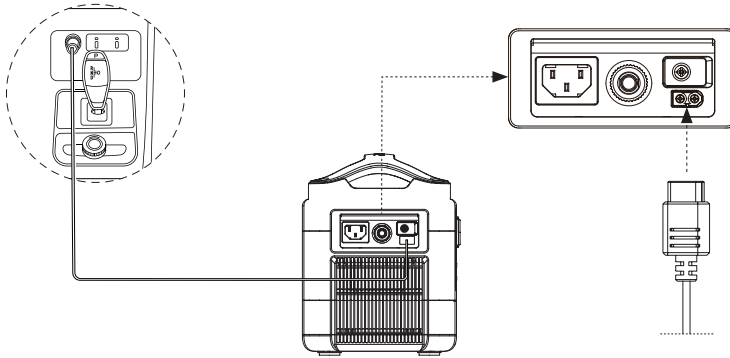

3.7 APP

The EcoFlow App gives users the ability to control and monitor EcoFlow power stations remotely.

Read the EcoFlow App user guide and access the download link here:

<https://ecoflow.com/pages/ecoflow-app>

Privacy Policy

By using EcoFlow Products, Applications and Services, you consent to the EcoFlow Term of Use and Privacy Policy, which you can access via the "About" section of the "User" page on the EcoFlow App or on the official EcoFlow website at <https://ecoflow.com/pages/terms-of-use> and <https://ecoflow.com/pages/privacy-policy>



3.8 X-Boost

With EcoFlow X-Boost technology, the product can power a 1800W Max device while the rated output power remains 600W, avoiding operation failure due to overload protection. Under standard voltage conditions, the total maximum output of all AC output ports is 600W. With the X-Boost enabled, all AC output ports can power devices that require 1800W Max in total while the rated output power remains 600W. The X-Boost will be automatically enabled when the total output of all output ports exceeds 600W. supports 1800W max devices while the rated output power is still 600W.

X-Boost Tips:

1. X-Boost is enabled by default; you can enable or disable it in the EcoFlow App.
2. X-Boost is not available when the AC output is turned on in a recharging state (in bypass mode) and when X-Boost is disabled.
3. X-Boost is not applicable for all electrical appliances; it's incompatible with appliances with strict voltage requirements. Appliances with voltage protection (such as precise instruments) are not supported. X-Boost mode is more suitable for heating devices. Please conduct your own tests with your devices with X-Boost enabled.

3.9 Emergency Power Supply (EPS)

The product supports EPS. When you connect the grid power to the AC Input Port of the product through an AC Charging cable, you can power electrical devices through the AC Output Sockets (AC power will come from the grid and not the power station in this situation). In case of a sudden blackout, the product can automatically switch to the battery powered supply mode within 30ms. As a basic UPS function, this function does not support 0ms switching. Please do not connect the product to any device that requires 0ms UPS, such as data servers and workstations. Please test and confirm the compatibility before using the product. We recommend that you only charge one device at a time and avoid using multiple ones at the same time to avoid overload protection. EcoFlow takes no responsibilities for any device failures or data losses caused by failures to follow instructions. The EPS of the product only supports the following loads: below 600W.

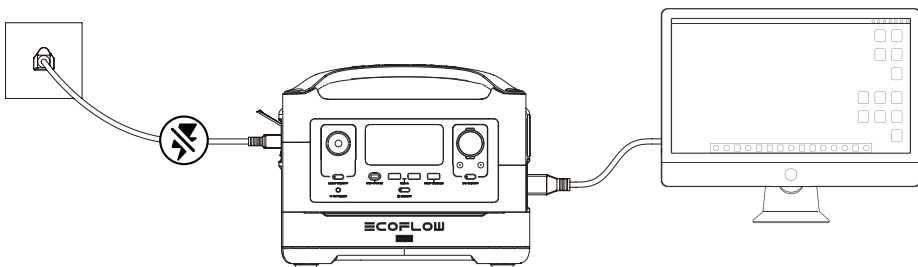

4. FAQs

1. What battery does the product use?

It uses high-quality lithium-ion battery.

2. What devices can the product's AC output port power?

With 600W rated power and 1200W peak power, the product's AC output port can power most household appliances. Before you use it, we recommend that you confirm the power of the appliances first and ensure the power sum of all loaded appliances is lower than the rated power.

3. How long can the product charge my devices?

The charging time is shown on the product's LCD Screen, which can be used to estimate the charging time of most appliances with stable power usage.

4. How can I know if the product is charging?

When it's charging, the remaining charging time will be shown on the LCD Screen. Meanwhile, the charging indicator icon begins to rotate with the remaining battery percentage and the input power shown on the right of the circle.

5. How to clean the product?

Please gently wipe it with a dry, soft, clean cloth or paper towel.

























6. How to store the product?

Before storing, please turn off the product first, and then store it in a dry, ventilated place at room temperature. Do not place it near water sources. For long-term storage, please discharge the battery to 30% and recharge it to 60% every three months to extend its battery life.

7. Can I bring the product on a plane?

No.

5. Troubleshooting

Indicator		Problem	Solution	
RECHARGING TIME	   Icons Flash together	High Temperature Charge Protection	Charging can be resumed automatically after the battery cools down.	
	   Icons Flash together	High Temperature Discharge Protection	The power supply can be resumed automatically after the battery cools down.	
RECHARGING TIME	   Icons Flash together	Low Temperature Charge Protection	Charging can be resumed automatically after battery temperature rises above 41°F.	
	   Icons Flash together	Low Temperature Discharge Protection	The power supply can be resumed automatically after the battery temperature rises above 10°F.	
	OVERLOAD	Icons Flash together	Overload Discharging Protection	Battery Exclamation and OVERLOAD icons flash together. Disconnect all appliances, restart the RIVER Max, and add each appliance back in in turn. Please note that electrical appliances must be operated within rated power.
	 50Hz	Icons Flash together	AC Output Overload Protection	Normal operation will be resumed automatically after you remove the overloaded device and restart the product. Electrical appliances should be used within rated power. (Refer to X-Boost instructions to get more details about power limitations).
 50Hz	  Icons Flash together	AC High Temperature Protection	Please confirm whether the fan inlet and outlet are blocked, if not, normal operation will be resumed automatically after the product temperature drops.	
 50Hz	  Icons Flash together	AC Low Temperature Protection	Normal operation will be resumed automatically after the product is used at optimum environmental temperatures.	
	 Icon Flashes	Fan Blockage	Please check if the fan is blocked by foreign materials.	
©Car	OVERLOAD	Icons Flash together	Car Charger Overload Protection	The product will resume normal operation automatically after you remove the device connected to the car charger.
©Car	  Icons Flash together	Car Charger High Temperature Protection	After the product cools down, it will resume normal operation automatically.	
	 Icon Stays On	Battery Failure	Contact EcoFlow Customer Service	

If the Alarm Prompt shows on the product LCD screen during use and does not disappear after a restart, please stop using it immediately (do not try to charge or discharge).

If you require any other assistance, please contact EcoFlow Customer Service.

6. What's In the Box

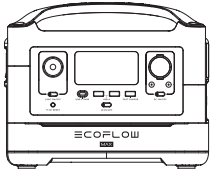

EcoFlow RIVER Max

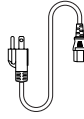

AC Charging Cable (1.5m)

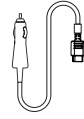

Car Charging Cable
(1.5m)

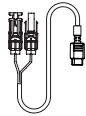

Solar Charging Cable
(MC4 to XT60 Input)

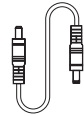

DC5521-DC5525
Cable

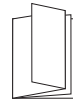

User Manual and War-
ranty Card

7. Storage & Maintenance

1. Please use or store the product in an environment temperature between 68°F to 86°F, away from water, heat, and other metal objects.
2. For long-term storage, please discharge the battery to 30% and recharge it to 60% every three months.
3. For safety, please do not store the product in an environment temperature higher than 113°F or lower than 14°F for a long time.
4. If the remaining battery is less than 1% after you finish using the product, please recharge it to 60% before storing. If the product is left idle for a long time with severely low battery, irreversible damages may be caused to the battery cell and the product service life will be shortened.
5. If the product has been idle for too long and the battery is severely low, it will enter a deep sleep protection mode. In such case, please charge the product before using it again.